

TITLE : DIGITAL STRIP CUTTER

MODEL : SEC-100HS (HOT KNIFE)

ASSEMBLING DRAWING PARTS LIST

1 Page : BED / SLIDER PARTS

2 Page : ROLLER PARTS

3 Page : BASE COVER PARTS

4 Page : CONTROL BOX PARTS

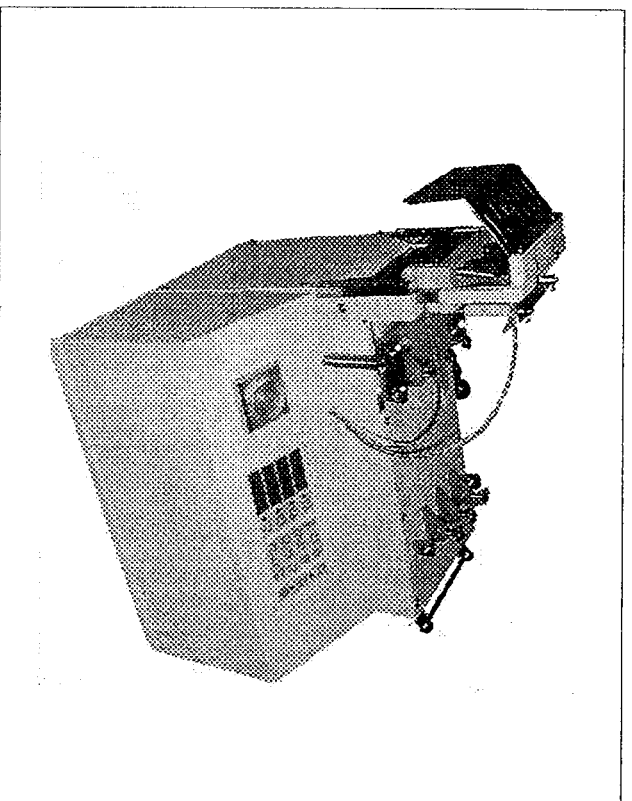

CONSEW®

CONSOLIDATED SEWING CORP.

INDUSTRIAL SEWING & CUTTING EQUIPMENT

Main office
131 West 25th Street
New York, New York 10001
Tel: 212-741-7788
Fax: 212-741-7787

Branch Office
7855 N.W.29th St. (#166)
Miami, Florida 33122
Tel: 305-471-0200
Fax: 305-471-0243

e-mail: consew@worldnet.att.net • web: www.consew.com

1. BED / SLIDER PARTS

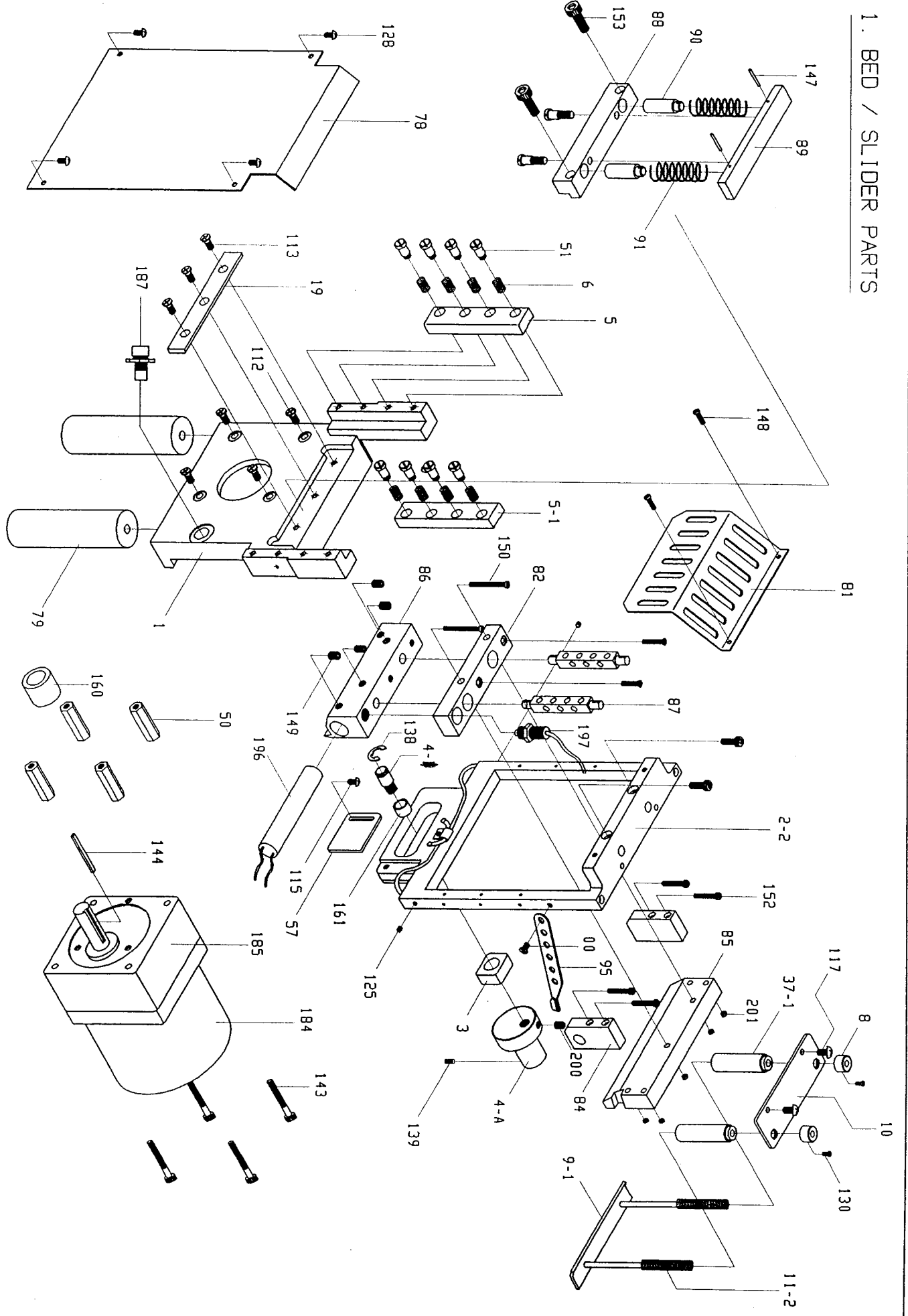

2. ROLLER PARTS

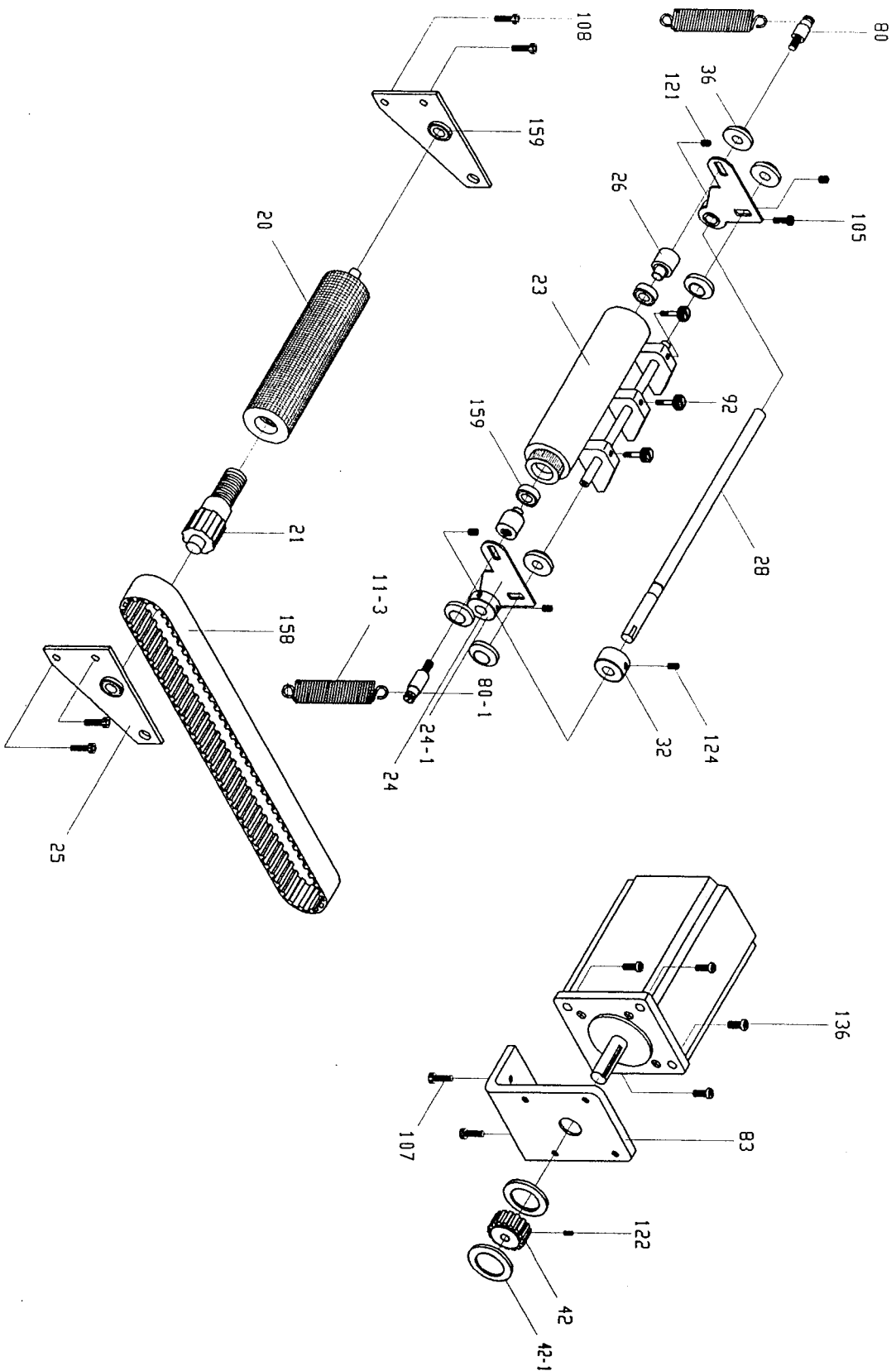

3. BASE COVER PARTS

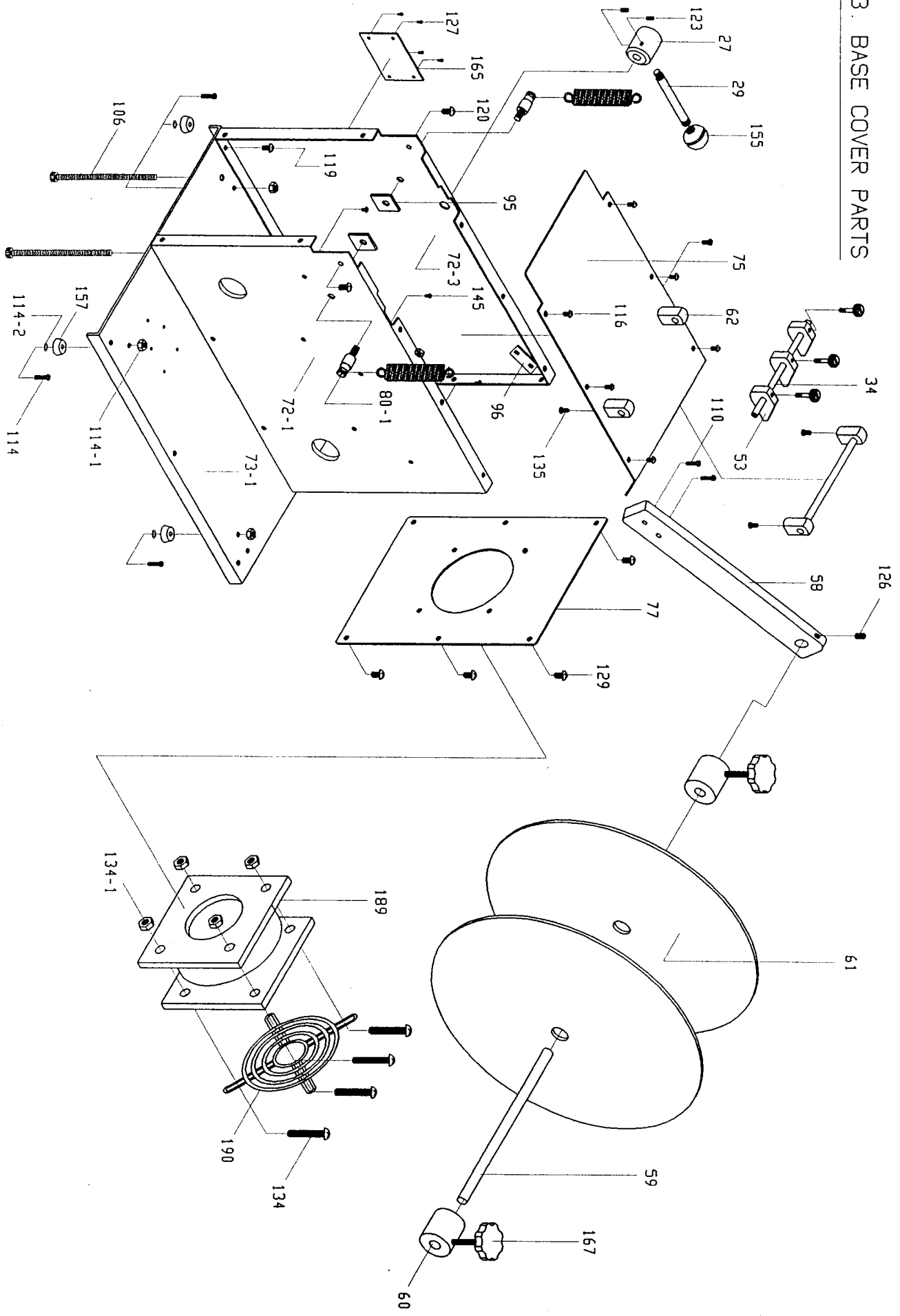

4. CONTROL BOX PARTS

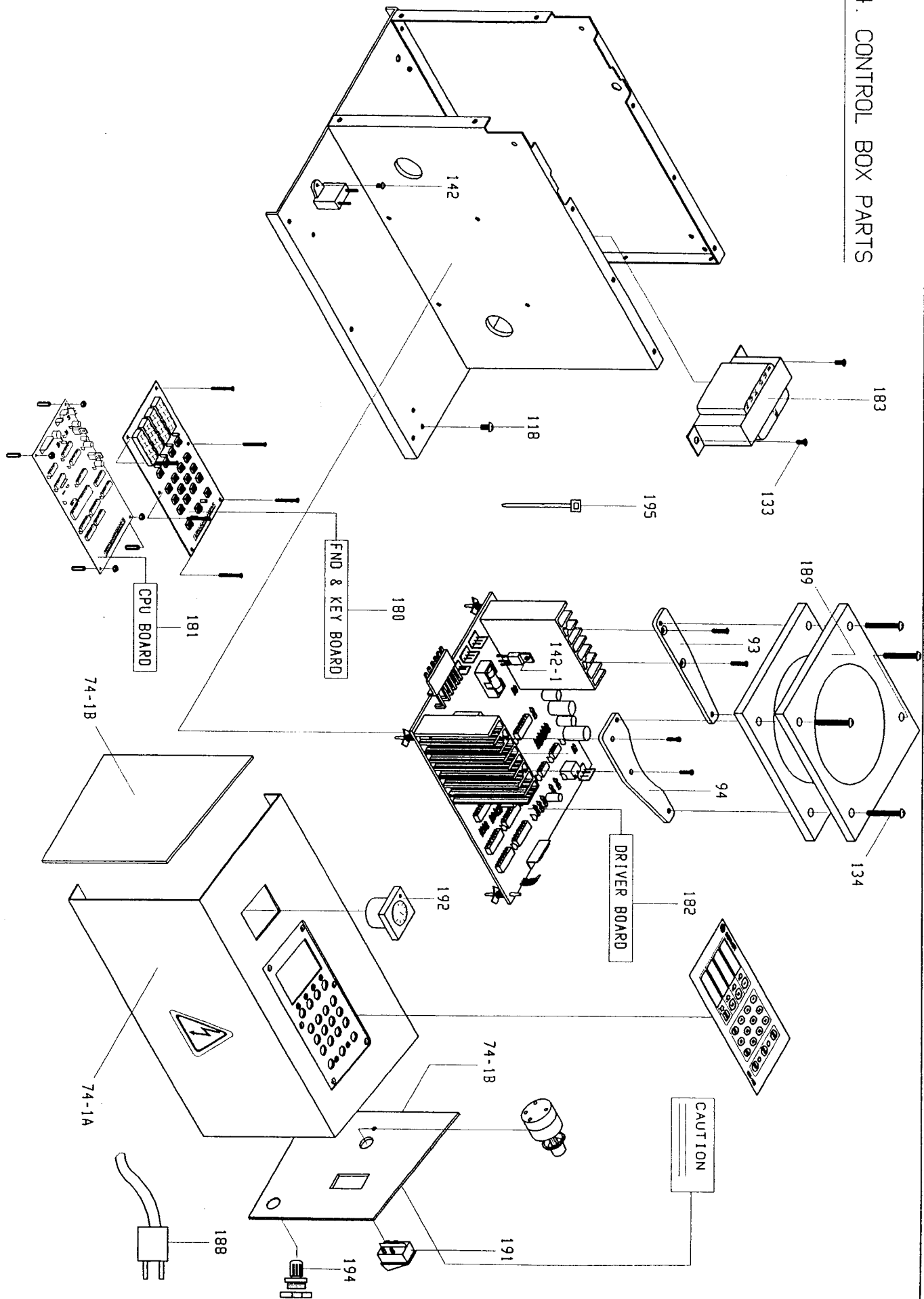

SEC-100HS OPERATING MANUAL

※ SEC-100HS is the High Grade Digital Strip cutting Machine which is specially designed to be operated very easily and controlled by built-in High Technology Micro Computer which has so many functions in it.

※ Please kindly refer to the below manual precisely before your operating.
We hope that this machine will be very helpfulness for your business.

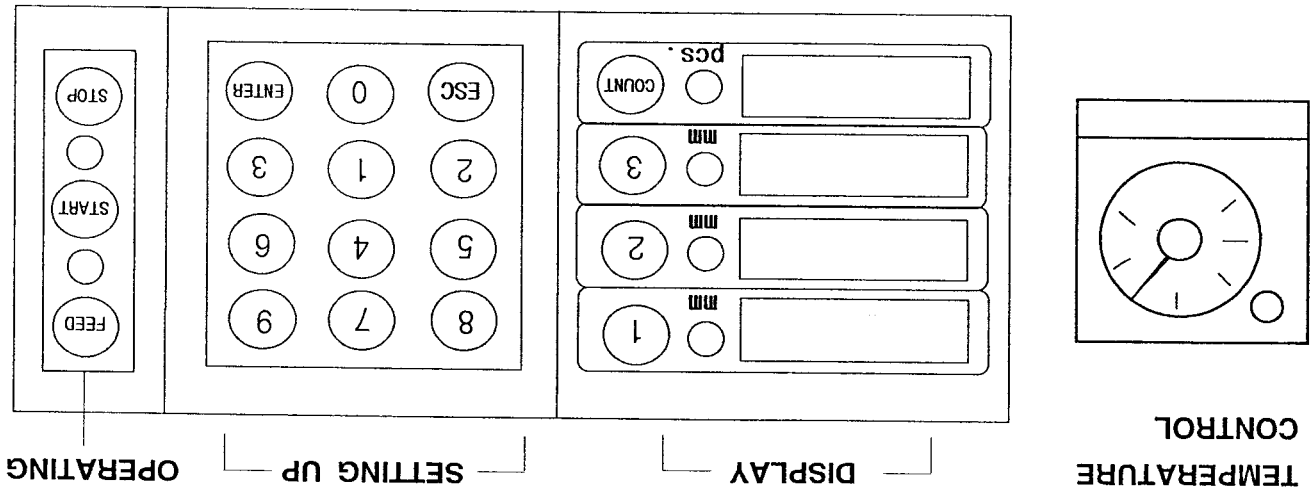

1. Control box of SEC-100HS is composed of 4 panels and Fusing timer.

Display panel, Setting up panel, Operation panel, Temperature panel, Fusing timer

1) DISPLAY PANEL : There are 4 indicating window in this panel.

Window ①, ②, ③ is indicating the length of tape to be cut and it in Millimeters. Counter button of window is indicating the quantity to be cut.

2) SETTING UP PANEL : You can set up the length and quantity very easily only by pressing figure buttons in this panel in order that the tape will be cut as you want.

3) OPERATING PANEL : **FEED** - While you are pressing this button, the tape will be moved into the roller inside. You can put the tape into the machine very easily by pressing this button.
START - Machine start to cut the tape by pressing this button.
STOP - Machine stop cutting tape by pressing this button.

This button is use also for emergency stop.

4) TEMPERATURE CONTROL PANEL : You can control temperature by return round. Please use adjust with solid-state temperature according to the type of material to be cut.

5) FUSING TIMER : Provided with adjustment devise of fusing time for cut thick tape.

2. HOW TO SET UP AND OPERATE.

(1) How to set up length of tape to be cut.

Press window button ① or ② or ③ which you want to set up first in the indication panel then you will see the blinking signal from your selected window. Then you can set up required length by pressing the figure button in the setting up panel and then press Enter button to fix the length firmly. You can set up other required length to the balanced windows same way as above.

A. To start cutting operation, please select the window which is showing your required length by pressing window button ① or ② or ③ then press Enter button or Esc button to fix the length you required. And then press start button. Then automatically the tape will be cut as per your required length continuously before you press stop button.

(2) HOW TO CHANGE THE LENGTH WHICH WERE FIXED IN THE WINDOWS.

FUSING TIMER

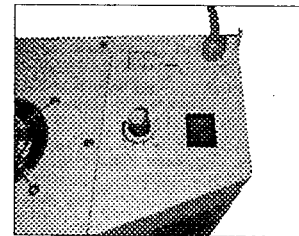

DISPLAY PANEL

0 2 0 0	mm	①
0 3 0 0	mm	②
0 4 0 0	mm	③
9 9 9 9	pcs	COUNT

SETTING UP PANEL

ESC	0	ENTER
1	2	3
4	5	6
7	8	9

Select one window that you want to change length and press that window button. You can see the blinking signal then you can reset the length by pressing enter button to fix the length firmly. To start operating, please refer to the above manual 2-Ā.

(3) HOW TO USE COUNTER WINDOW AND COUNTER BUTTON.

This counter window is specially designed to stop machine automatically upon your required quantity being cut. For example if you set 100pcs in the counter window, and press start button, the machine will operate and will stop automatically after 100pcs being cut. To set up and reset the quantity, please use the same way as setting up length.

(4) This machine has attached with adjustment device of fusing time. This machine stops operation for the duration of time set by the time when the tape is being fused (during this time, fusing is in progress). Fusing time is adjustable from 0 second to 5 seconds.

Sales company

LONSEM®