

CONSEW *Since 1898*®

CONSOLIDATED SEWING MACHINE CORP.

└ INDUSTRIAL SEWING & CUTTING EQUIPMENT

OPERATING INSTRUCTIONS

254RB-3

CONSEW *Since 1898*®

CONSOLIDATED SEWING MACHINE CORP.

└ INDUSTRIAL SEWING & CUTTING EQUIPMENT

400 VETERANS BLVD, CARLSTADT, NJ 07072



CONTENTS

	Page
Setting up the machine	1
Oiling and it's adjustment	1
Oil adjuster	2
Needle and thread	2/3
Inserting and removing bobbins	3
Winding bobbins and it's adjustment	3
Threading the machine	4
Regulating the thread tension	5
Adjustment of the presser feet pressure	5
Adjusting the stitch length and reverse stitch	6
Adjusting the left of the alternating presser feet	6
How to reset the safety clutch mechanism.....	7

INFORMATION FOR ADJUSTMENT

Replacement of the timing belt	7
Adjusting the height of the feed dog	8
Adjusting the timing of the needle plate, needle and feeder.....	9
Adjusting the height of the needle bar	10
Timing between the hook and needle.....	10
Relative position between bobbin case and opener	11
Adjusting the height of the presser feet.....	11
Timing of the vibrating presser foot	12
Adjusting the thread controller spring.....	12
Fine adjusting of the lifting presser foot.....	13
Changing the needle gauge	13

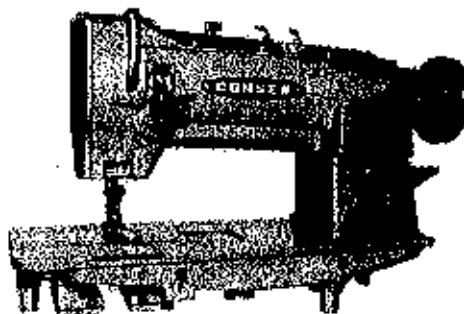
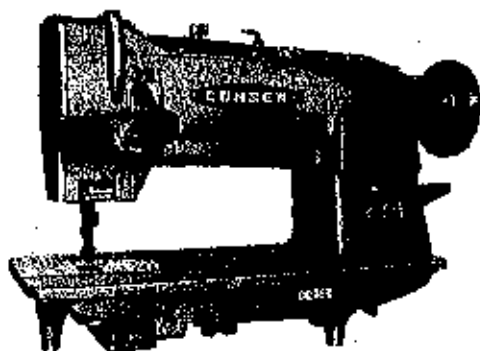

SETTING UP THE MACHINE

Before setting up the machine on the table, attach the relative parts to the table.

- | | | |
|--------------------|---------------------|-----------------|
| 1. Hinge | 2. Motor | 3. Oil pan |
| 4. Oil bottle | 5. Knee lifter | 6. Stand |
| 7. Treadle | 8. Machine rest pin | 9. Cotton stand |
| 10. Cushion rubber | 11. Head of machine | 12. V belt |
| 13. Bobbin winder | | |

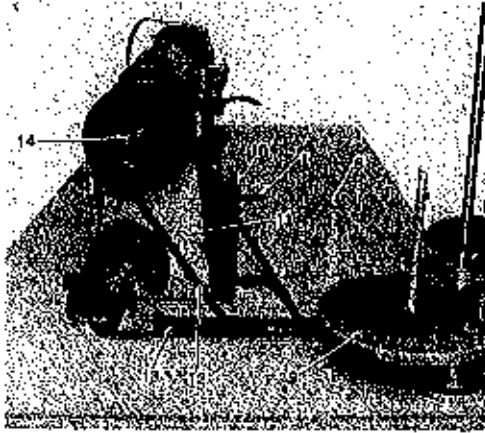

Fig. 1



Fig. 1

OILING AND IT'S ADJUTMENT

Do not operate the machine, even if for testing, unless it has been properly oiled.

(1) To fill the oil reservoir on top of the machine, pour oil through the oil filler hole (A), until oil level reaches to the upper reference line.

Oiling is automatically made by the vibration of the machine while sewing operation through the oiling wicks in the machine, and oil flow stops automatically when the operation of the machine ends.

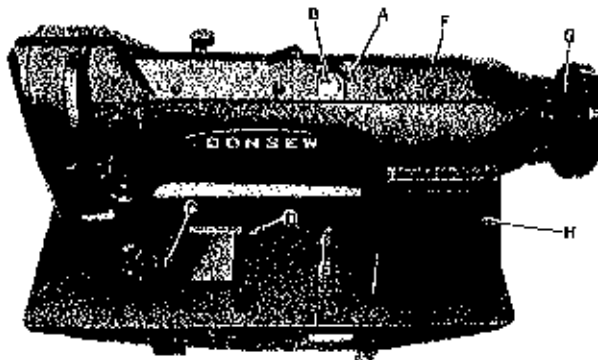

Fig. 2



Fig. 3

(2) The hook mechanism should receive careful attention when lubricating the machine.

Push open the slide plate in the bed (the right and left plates in case of two needle machine) and pull out the oil gauge (C). Fill oil in the reservoir for the rotating hook mechanism up to the level marked on the oil gauge.

Care must be taken that oil flow stops when oil level falls to the bottom.

(3) Oiling adjustment to the hook mechanism.

The maximum oil flow is made when the reference line on the oil adjusting knob (2) is in a line with the point (1), and it stops when the reference line is upright.

To adjust this, loosen the pinch screw (3) and turn the oil adjusting knob, then tighten the pinch screw.

OIL ADJUSTER

Oiling to inside of arm top cover is automatically made by the vibration of the machine while sewing operation.

Stop oiling temporarily by the following method at your option in case of long sewing operation.

When point of the dial enters into point of arm bed cover after turning the dial, the dial goes down and oiling stops completely.

NEEDLE

The size of the needle to be used should be determined by the size of the thread, which must pass freely through the eye of the needle.

To insert the needle, turn the machine pulley over toward you until the needle bar (1) moves up to it's highest point, loosen the needle set screw (2) and put the needle up into the needle bar as far as it will go, with the long groove of the needle toward the left (but, toward inside direction in case of two needle machine), and tighten the needle set screw securely.

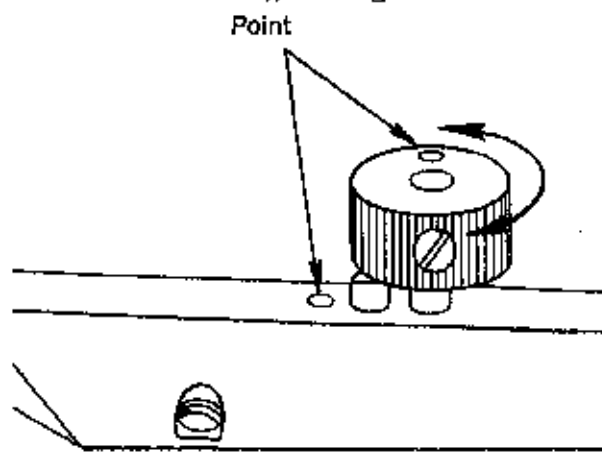

OIL ADJUSTER

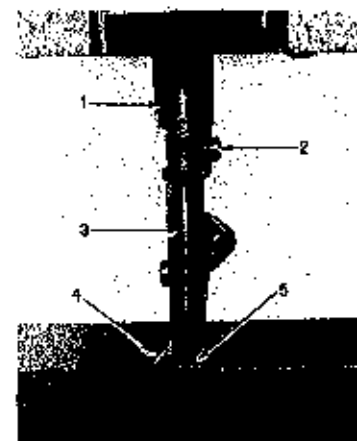

Fig. 4

3

THREAD

Cotton, synthetic or silk thread can be used according to your purpose, the thickness of thread is up to # 8.

Left twist thread should be used in the needle, but either right or left twist thread can be used in the bobbin.

In case of two needle machine, use right twist thread in the left needle for perfect stitching.

INSERTING AND REMOVING BOBBINS

Push open the slide plate (1), (in case of two needle machine, left-hand and right-hand plates). Pull up the latch (2) of the bobbin case and lift the bobbin (3) out of the bobbin case.

To insert a full bobbin in the bobbin case, hold it between thumb and index finger of your right hand. Place the bobbin on the center post of the bobbin case and push down the latch (2).

Be sure that the thread draws out from the bobbin from left to right.

Pull the thread into the slot (4) and between the bobbin case opener (5) and the projection (6) and under the tension spring (7).

Draw out about 5 mm of the thread on the needle plate and close the slide plate leaving a sufficient space for passage of the thread.

WINDING BOBBINS AND ITS ADJUSTMENT

Push a bobbin on the bobbin winder spindle (1) as far as it will go. Pass the thread from the thread stand downward through the eye (7) in the tension bracket, then between and around the back of the tension disc, bring the thread forward toward the bobbin and wind from below in clockwise direction several times around the bobbin.

Push bobbin winder lever (3) downward until the wheel (2) contacts the drive belt and then start the machine.

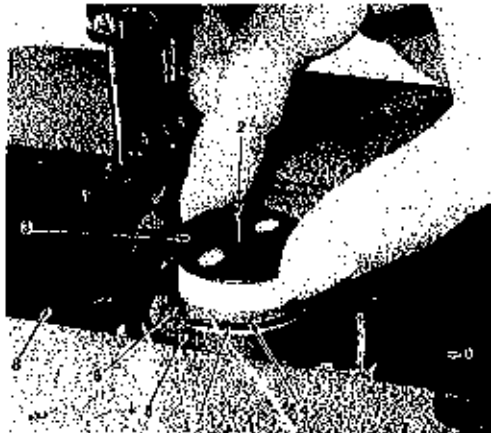

Fig. 5

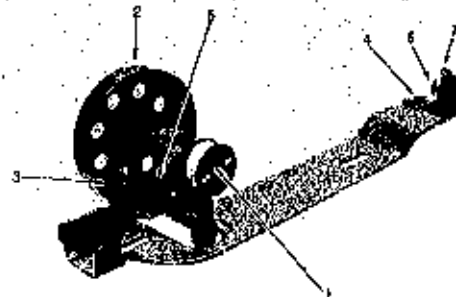

Fig. 6

After the bobbin is filled with thread, release will cause wheel to disengage from the belt and winding will stop.

Cut the thread and remove the bobbin from the spindle.

Adjustment screw (5) can be turned in or out to increase or decrease the amount of thread wound on the bobbin.

When fine thread is wound on bobbins, use light tension.

It is regulated by turning the knurled nut (6) on the tension bracket at the rear of the bobbin winder.

Bobbin can be wound while the machine is sewing.

If the thread does not wind evenly on the bobbin, loosen the screw (4) in the tension bracket and move the bracket to the right or left as may be required, then tighten the screw.

THREADING THE MACHINE

Raise the needle bar to its highest point.

From the thread stand, lead the thread to the thread guide (1) on top of the machine arm, down to the upper guide hole of the thread guide (2) from right to left. Pass the thread in weaving fashion through the other two holes in (2) and from right to left over and between the tension discs (3). Now pull the thread downward from right to left beneath and around thread controller (4), continue to pull the thread upward through the fork in the thread controller and against the pressure of the check spring (5) and through the thread guide (6), pull the thread upward through the eye in the take-up lever (7) down through the thread guide (6) again and then through the thread guide (8) and (9) and from left to right through the eye of the needle.

(In case of the two needle machine, pass the thread through the eye of the needle from inside to outside).

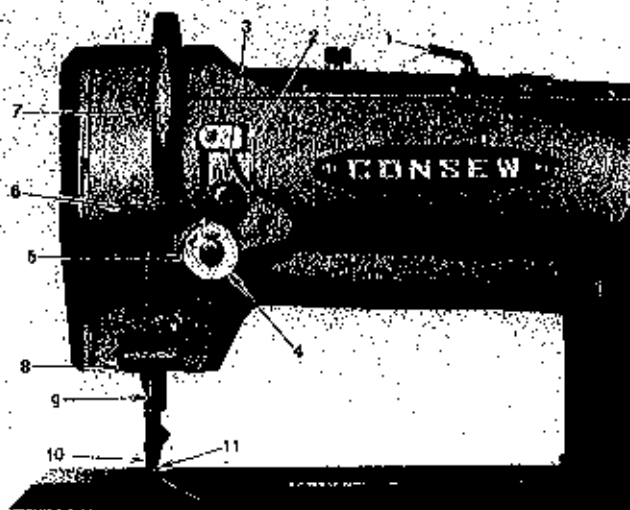

Fig. 7

5

REGULATING THE THREAD TENSIONS

For ordinary stitching, the tension of the upper and lower threads should be equal so as to lock both threads in the center of the fabric. If the tension on either thread is stronger than on the other, imperfect stitching will be the result.

If the tension on the upper thread is greater than that on the lower thread, it will be straight along the upper surface of the fabric.

If the tension on the lower thread is greater than that on the upper thread, the lower thread will lie straight along the underside of the fabric.

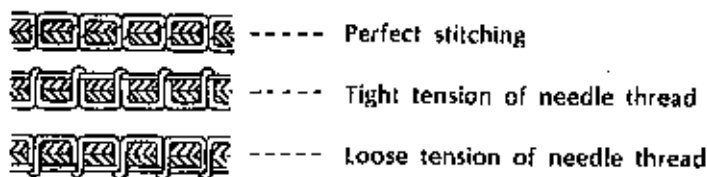

Fig. 8

A. TENSION OF THE UPPER THREAD

To adjust the tension of the upper (Needle) thread, turn the serrated nut (1) to the right for increasing tension. If you desire to decrease it, turn the nut to the left.

B. THE TENSION OF THE BOBBIN THREAD

It is regulated by means of the tension screw (1).

To increase the tension, turn the screw to the right, and to decrease it, turn the screw to the left by a screw driver.

ADJUSTING OF THE PRESSER FEET PRESSURE

The pressure of the presser feet is regulated by the adjusting screw (1).

To increase the pressure, turn the screw to the right and to decrease it to the left by a screw driver.

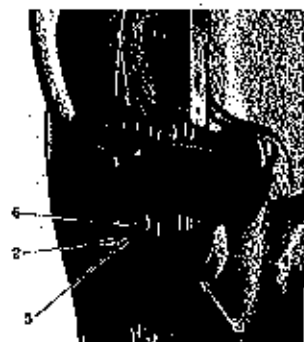

Fig. 9



Fig. 10

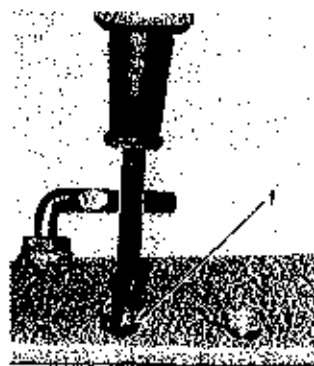

Fig. 11

ADJUSTING THE STITCH LENGTH

The stitch length is changed by pressing down the button (D, Fig. 2) in the bed plate of the machine and by simultaneously turning the handwheel slowly toward you.

In due course, the plunger will enter into a notch in the feeding mechanism.

Hold the plunger down and continue to turn the handwheel, either forward or rearward, until the marking with the desired number of stitches on the handwheel coincides with the reference mark on the arm. Then release the plunger.

Numerals on pulley show number of stitch per inch	Stitch length (m/m)
3	9
4	6.5
5	5
6	4.2
7	3.6
8	3.2
9	2.8
10	2.5
12	2.1
16	1.6
20	1.2
24	1

REVERSE STITCH

To do tacking for the purpose of locking the ends of seams, rapidly depress and release the lever (4, Fig. 15).

When reversing feed of the machine, keep the lever (4) depressed as long as required. For all other forward stitching, the lever remains in up position.

HOW TO RE-SET THE SAFETY CLUTCH MECHANISM

The sewing hook and it's mechanism are protected by a safety clutch. In case the hook gets jammed with thread or other foreign matter, the safety device disengages the driving belt, stops sewing, and thus prevents the machine from getting damaged. If it should become necessary to re-engage the safety clutch, depress the button (E, Fig. 2) in the bed plate, at the same time, turn the handwheel away from you until the locking mechanism re-engages the drive shaft beneath the bed of the machine, open the slide plate above the hook and rock handwheel back and forth to remove any foreign matter which may have lodged in the hook.

Do not use any sharp-edged tools, etc. lest the hook be damaged.

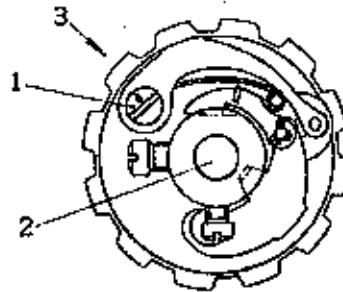

Fig. 13

REPLACEMENT OF THE TIMING BELT

1. INSERTING THE BELT

Turn the balance wheel toward you until the take-up lever reaches to its highest point.

Turn the lower shaft (1) until the arrow mark on the lower shaft bearing collar (2) meets with another arrow mark on the timing plate (3).

Insert a new timing belt into the belt pulley at this position.

2. REMOVING THE TIMING BELT

Remove the arm top cover (F, Fig. 2) and remove the timing belt from the belt pulley, loosen the collar set screw (1, Fig. 15).

Loosen the two set screws (G, Fig. 2) for the hand pulley and remove the hand wheel adjusting screw (1, Fig. 14), draw out the hand wheel from the arm shaft.

Loosen the arm shaft rear bushing set screw (2, Fig. 15), pull out the rear bushing (3, Fig. 15) from the arm hole.

In case of the machine with reverse stitch mechanism, draw out the reverse lever (4, Fig. 15) with its shaft.

Removing or inserting the timing belt is made through the hole drawn out the rear busing.

After inserting the belt correctly, replace the rear bushing, screws, the arm top cover, etc. to their original places. Finally, adjust the timing marks mentioned in the item No. 1.

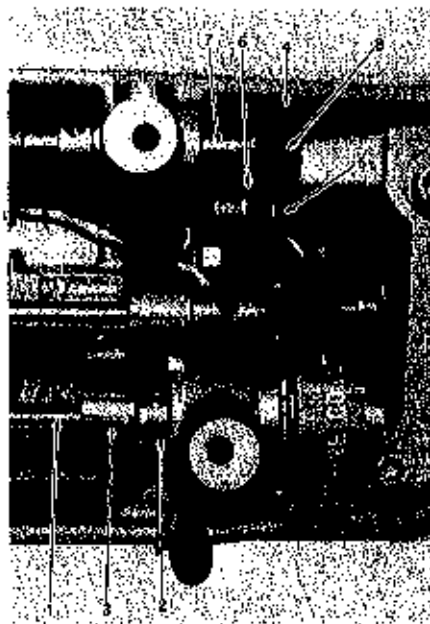

Fig. 14

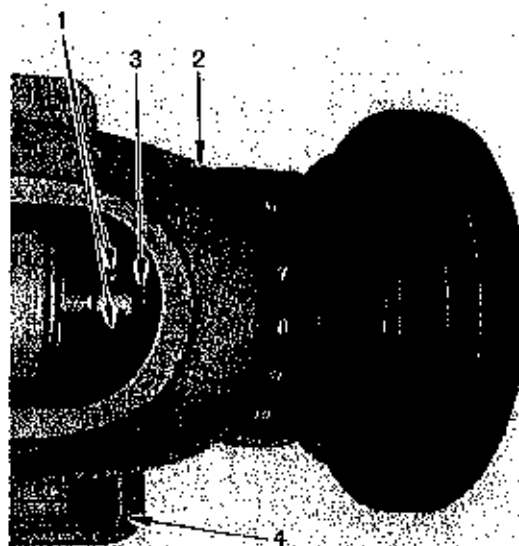

Fig. 15

ADJUSTING THE HEIGHT OF THE FEED DOG

The maximum height of the feed dog (1) from the surface of the needle plate (2) is normally 1 mm.

To adjust this height, tilt the machine, turn the handwheel so as to raise the feed dog to its highest point.

Loosen the set screw (4, Fig. 3) and raise or lower the feed dog as may be required.

Then, securely tighten the set screw.

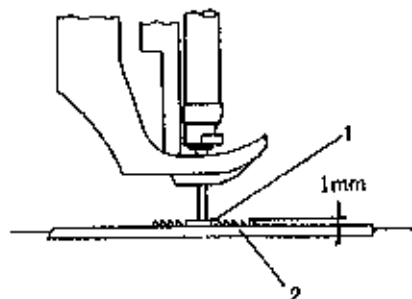

Fig. 16

ADJUSTING THE TIMING OF THE NEEDLE PLATE, NEEDLE AND FEEDER

1. THE POSITION OF THE FEEDER AGAINST THE NEEDLE PLATE

Adjust the feed motion to the minimum and loosen the screw (4, Fig. 14).

Set the needle hole (1) on the feeder to 1.5 mm from the center (A) of the hook, and after this adjustment, tighten the screw.

2. THE POSITION OF THE NEEDLE AND THE NEEDLE HOLE OF THE FEEDER

To adjust this, turn the hand pulley until the needle bar raise to its highest point and put a perfect needle.

Turning the handwheel to lower slowly the needle bar, check whether the needle descends to the center of the needle hole of the feeder or not.

If the needle does not enter into the center of the hole, remove the side plate (H, Fig. 2), loosen the screw (1, Fig. 18) through the window of the arm.

Holding the bottom of the needle bar rock frame (1, Fig. 19), move it as may be required for getting the correct position to the feeder.

Then, tighten the screw and side plate.

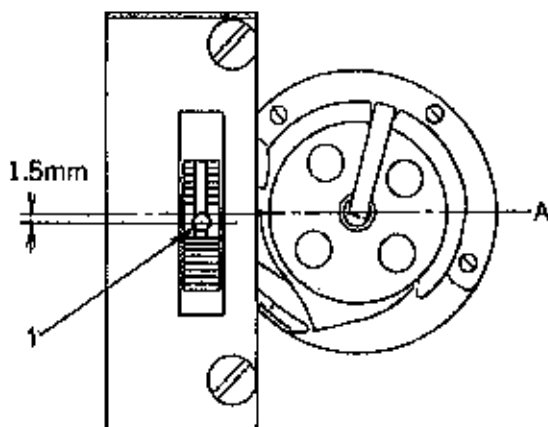

Fig. 17

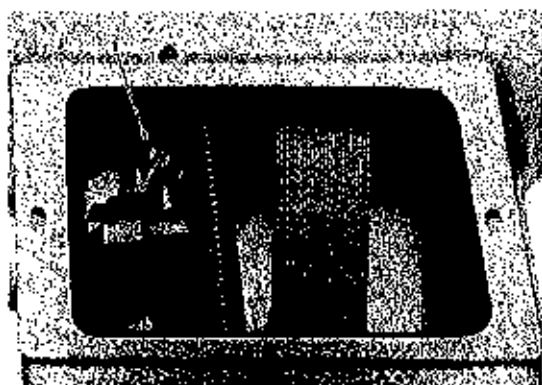

Fig. 18

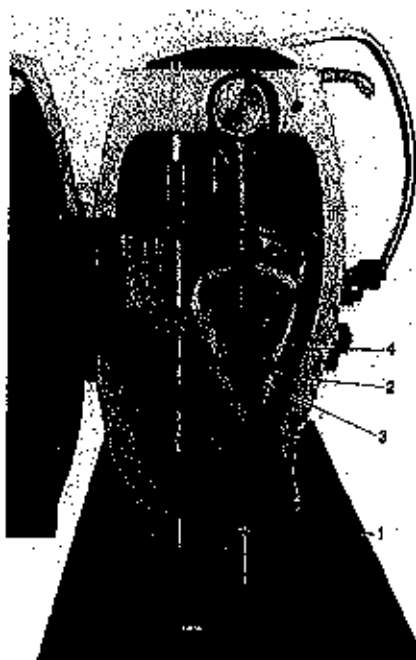

Fig. 19

ADJUSTING THE HEIGHT OF THE NEEDLE BAR

1. When the needle bar is at its highest point, normally the measurement between the surface of the needle plate and the upper end of the needle eye is 22.5 mm.

To adjust this, loosen the set screw (2, Fig. 19), move the setting position of the needle bar and the needle bar connecting stud (3, Fig. 19) to get the correct position. After this, tighten the set screw.

2. There is another method for this adjustment by setting the needle bar to its lowest point.

The normal position, in this case, is 4.2 mm approximately from the hook point to the upper end of the needle eye.

NOTE: These measurements are approximate standard, accordingly, following final adjustments are recommended.

TIMING BETWEEN THE HOOK AND NEEDLE

After setting the needle bar height as stated 1. or 2., confirm as follows:

Set the stitch length to 0, turn the balance wheel to lower the needle bar to its lowest point, turn the hand wheel toward you.

When the needle raises 1.8 mm from the lowest point of its travel, normally the hook point is at the center of the needle, and the measurement between the hook point and the upper end of the needle eye should be 2.4 mm, further the clearance between the hook point and the needle hollow should be about 0.05 mm to 0.2 mm.

If they are not measured as above, adjustments are made as follows:

1. TIMING ADJUSTMENT

Loosen two set screws (1, Fig. 21), move the gear (2, Fig. 21) to the left when making a faster motion of the hook against the needle. Move the gear to the right when adjusting a slower motion of the hook against the needle.

2. ADJUSTING THE CLEARANCE

Loosen the set screw (3) and (4) move the hook saddle (5) to the right or left to get the correct clearance and tighten the screws. Be sure to use perfect needle.

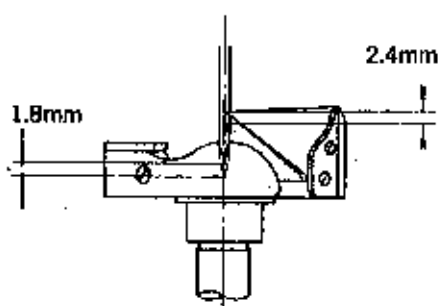

Fig. 20



Fig. 21

RELATIVE POSITION BETWEEN BOBBIN CASE AND OPENER

1. Loosen the screw (1), turn the balance wheel until the opener (2) is located at the extreme right hand position of its travel.
 2. In this position, adjust it so that the clearance between the inside edge of the opener and the tab on the bobbin case holder is about 0.2 mm.
- After the adjustment, tighten the screw securely.

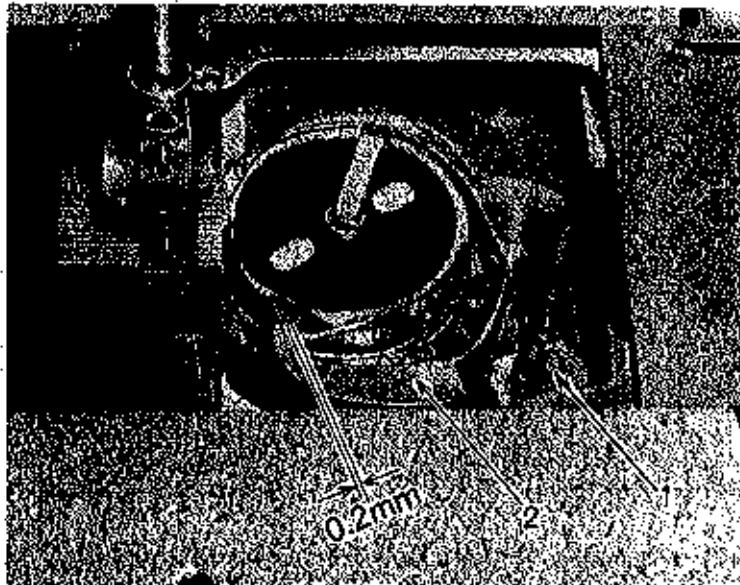

Fig. 22

TIMING OF THE VIBRATING PRESSER FOOT

This is the normal timing when turn the balance wheel toward you, after lowering the presser bar lifter, the vibrating presser foot should reach the feeder earlier than the needle eye comes to, and when the needle raises, the vibrating presser foot should leave the feeder after the needle eye has left the feeder.

This is due to the reason that the vibrating presser foot must tightly hold the goods while the needle is passing the goods for avoiding irregular stitches.

To adjust this, set the lift of alternating presser feet to equal, loosen the screw (3, Fig. 23) and adjust the rotating position of the cam (4, Fig. 23) faster or slower as desired, and tighten the screw.

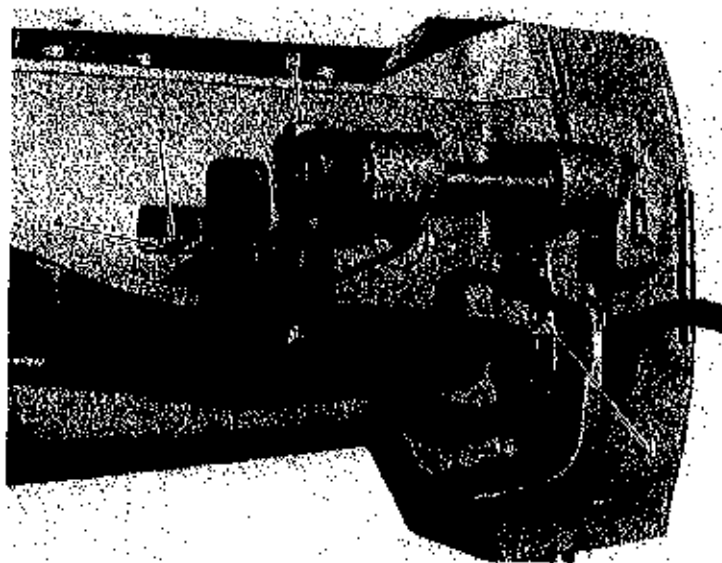

Fig. 23

ADJUSTING THE THREAD CONTROLLER SPRING

Normally, the thread controller spring (2, Fig. 2) should hold slack of the upper thread until the needle reaches to the goods, and it should pause while rising of the needle and passing of the upper thread through the bobbin case.

For more controller action on the thread, loosen the stop screw (3, Fig. 9) and set the stop to the right.

For less action, set the stop to the left. Then tighten the screw.

To strengthen the tension of the controller spring, loosen the serrated nut (5, Fig. 9) and the screw (4, Fig. 19) and turn the tension stud (6, Fig. 9) slightly to the left with a screw driver, or to lighten the tension, turn to the right.

Then tighten the screws and nut.

FINE ADJUSTMENT OF THE UPPER FEED

Ordinarily, the feeding momentum of the lower feed synchronizes with that of the upper feed. If, when the momentum does not synchronize, or increasing or decreasing that of the upper and needle feed according to the sewing conditions, the following adjustments are offered.

Loosen the nut (5, Fig. 14) and bring (6, Fig. 14) close to the feed driving rock shaft (7, Fig. 14) for more feed momentum or keep away from for less momentum. Tighten the nut firmly.

CHANGING THE NEEDLE GAUGE

1. In case of the two needle machine, remove the needles, presser foot, needle clamp, needle plate and feed dog in this order.

As the needle clamp is screwed in the needle bar, turn it counter-clockwise with a pair of pliers.

2. Put the desired needle clamp in place by screwing it tight into the needle bar.

3. Loosen the needle bar connecting stud set screw (2, Fig. 19) and turn the needle bar to correct the needle clamp's direction.

4. Set the correct timing between the hook and the needle.

5. Put the feeder, needle plate and presser foot in this order securely.

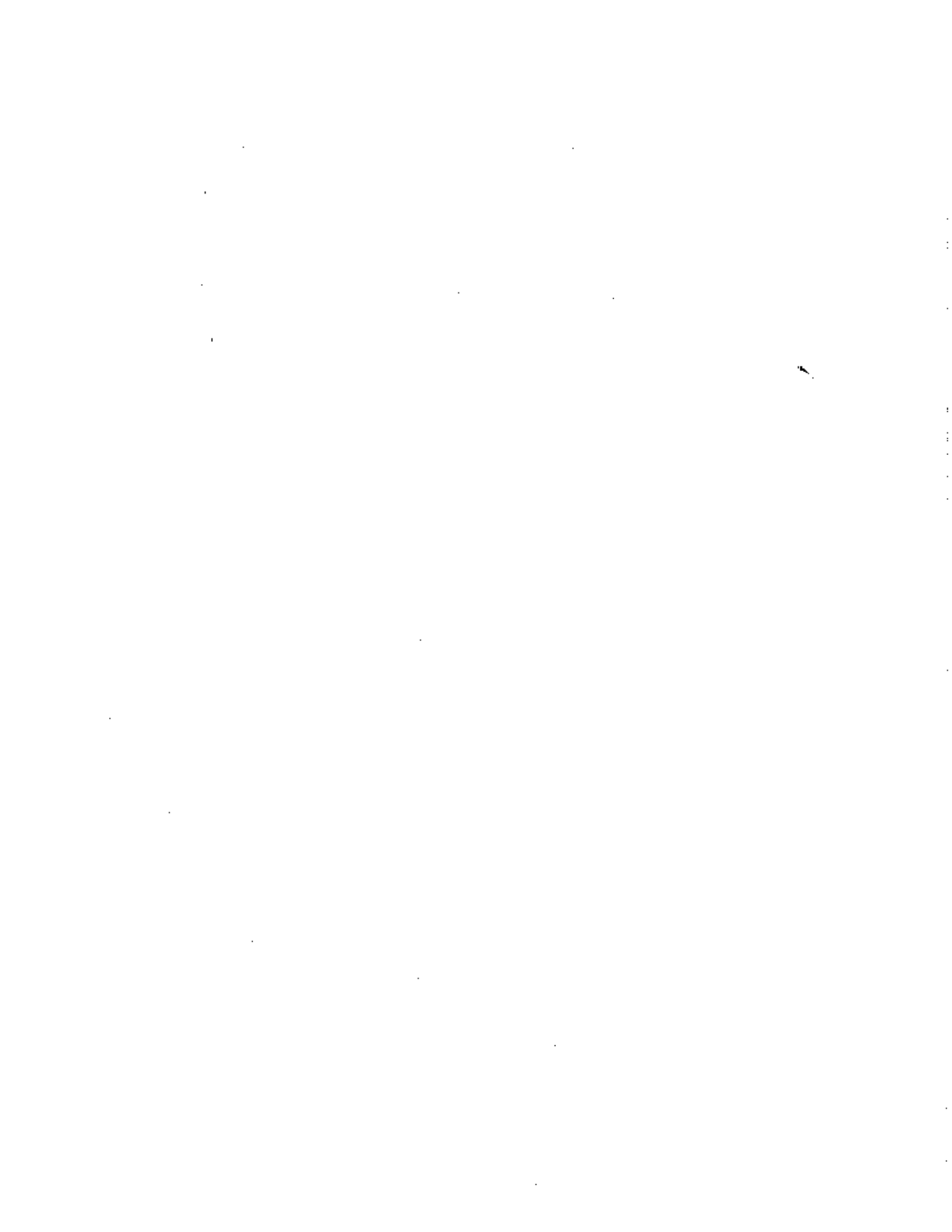

Consolidated Sewing Machine Corp.

MAIN OFFICE

131 West 25th Street
New York, NY 10001
Tel: (212) 741-7788
Fax: (212) 741-7787

BRANCH OFFICE

7855 NW 29th Street, Bay 166
Miami, FL 33122
Tel: (305) 471-0200
Fax: (305) 471-0243